

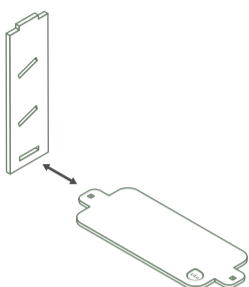

Estante Tema Livre

Deixe os encaixes que possuem travas, mais soltos durante toda a montagem. Trave tudo somente no final, como último passo.

1



2

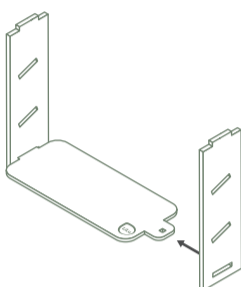

3

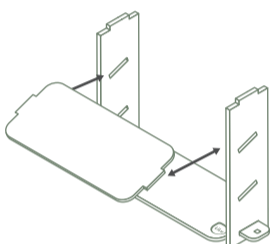

4

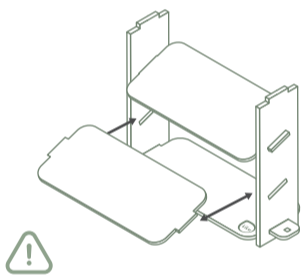

Certifique-se de que a prateleira de cima seja a peça que tem o encaixe mais largo.

5

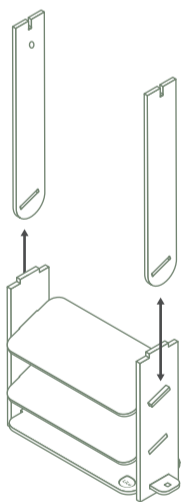

6

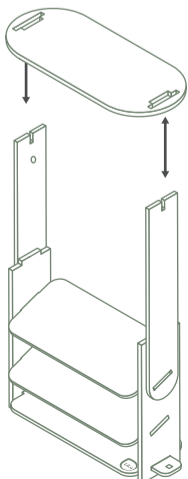

7

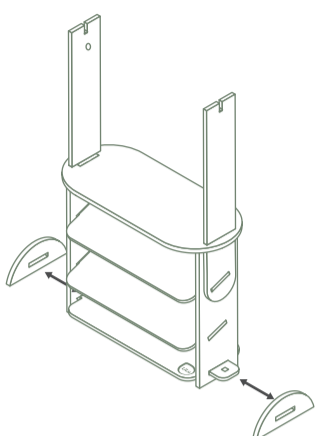

8

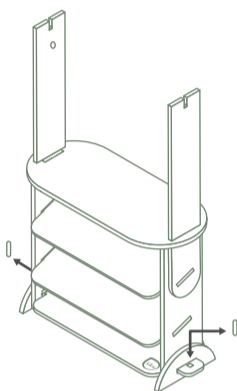

9

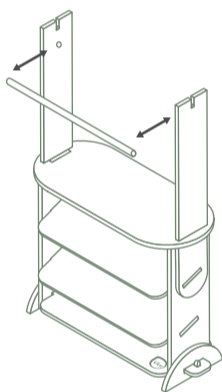

10

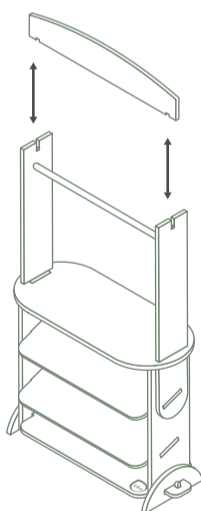

11

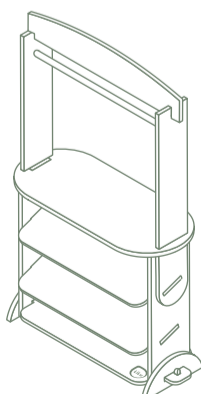

12 Pronto!

- . Limpar apenas com pano úmido
- . Permitted use of neutral detergent for heavier stains
- . Não utilizar produtos abrasivos